

# Zehnder Stana Neo

Product data sheet



The optimal radiator solution for the low temperature range. On the floor in front of a window or in an alcove. Zehnder Stana Neo enables ideal distribution of heated air throughout the room. The quiet, integrated fans provide greater output even at low system temperatures. The footplate of the convector elegantly conceals the connections. Understated design and a variety of models ensure that Zehnder Stana Neo fits perfectly into any setting. Available in almost any colour and finish from the Zehnder colour chart.

## Benefits

- Energy efficient – the model with fan assistance is ideal for operation with heat pumps and/or low temperature systems
- Closed design due to compact construction
- Short response time means rooms can be heated up rapidly
- High thermal output means large rooms are heated up rapidly
- Low height, ideal for use in front of glass fronts
- Invisible integrated connections in the footplate
- The mounting bracket makes it easy to install
- Quiet, integrated fans with easy to operate controller ensure considerably shorter heating-up phase and more performance, convenience and comfort
- Choice of various grille designs

## Model overview

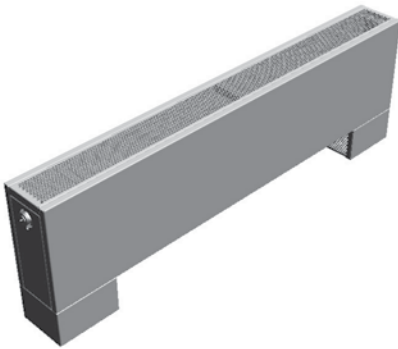

STF-028-014



STF-028-020

## All models

Technical specifications for length 1000 mm

Model	H <sup>1)</sup>	T	75/65/20 °C <sup>2)</sup>	55/45/20 °C <sup>3)</sup>	35/30/20 °C <sup>3)</sup>
	mm	mm	Watt	Watt	Watt
<b>STF-028-014</b>	380	140	1895	1100	434
<b>STF-028-020</b>	380	200	2189	1220	448

H = height, T = depth

1) Incl. foot 100 mm

2) Standard thermal output according to EN 16430 ( $\Delta T$  50K: 75/65/20 °C) at fan speed 2

3) Heat output at fan speed 2

Heat output of additional model lengths can be seen in technical documents.

# Zehnder Stana Neo

## Product details

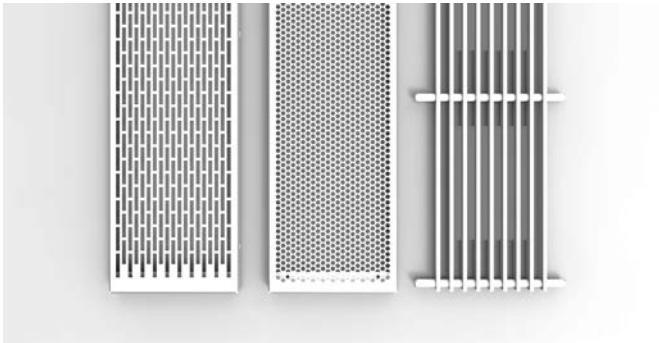

Grille with round holes structure (standard), rectangular holes or solid linear profiles

## Accessories



Digital room thermostat CU-24VDC-LCD

V20180723, RAD\_DAS, SI\_en, subject to change without notice