

TYPE PO/S90

© Copyright by PBO 03/17 1002974

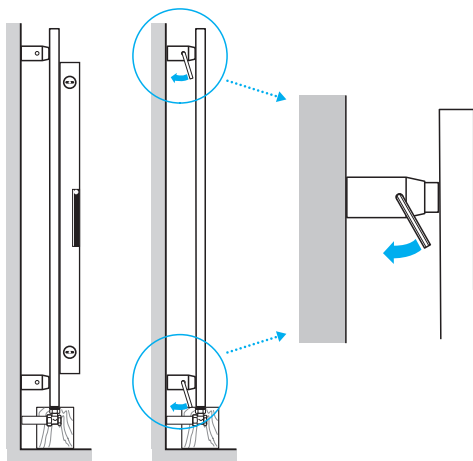
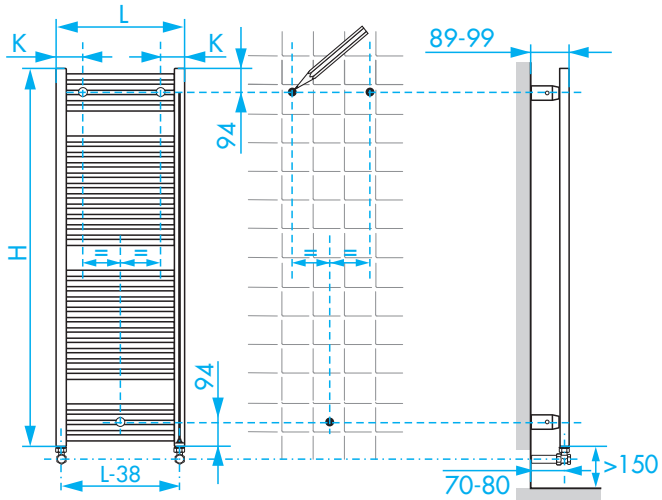
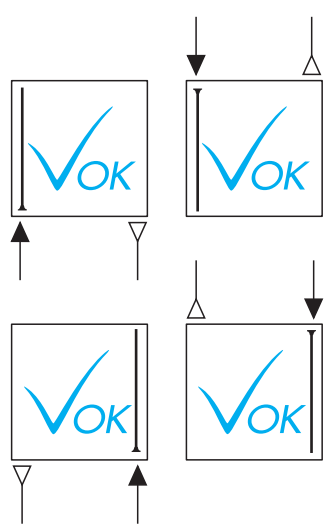
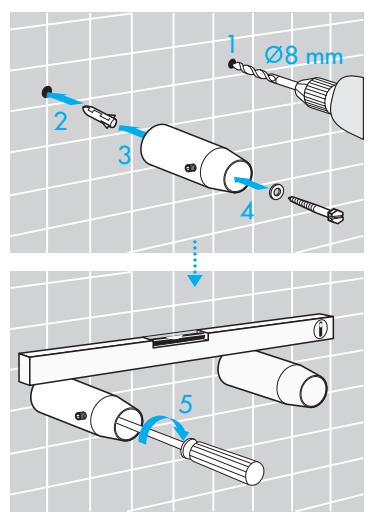
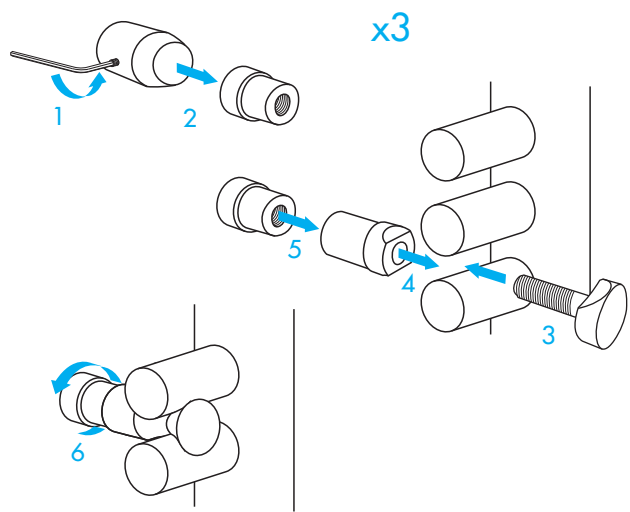
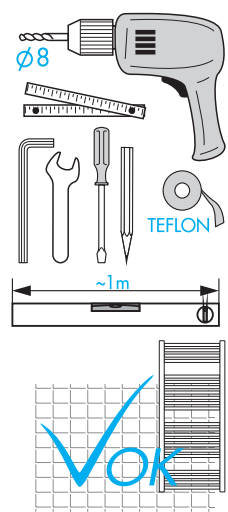
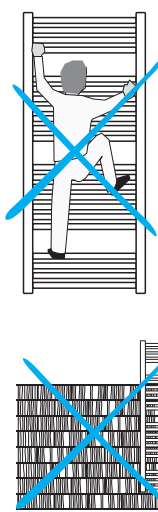
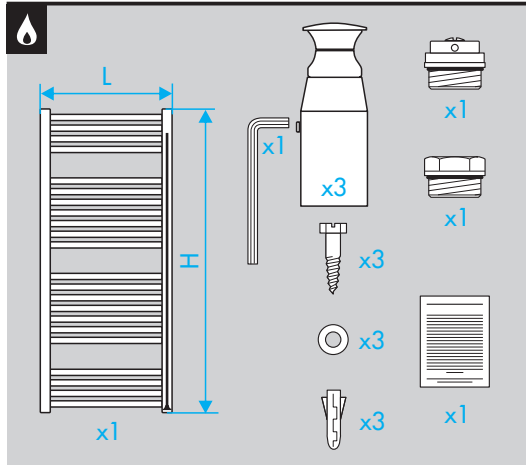

L	300	450	500	600	750
K	80	100	100	100	100

L	300	450	500	600	750
K	80	100	100	100	100

L	300	450	500	600	750
K	80	100	100	100	100

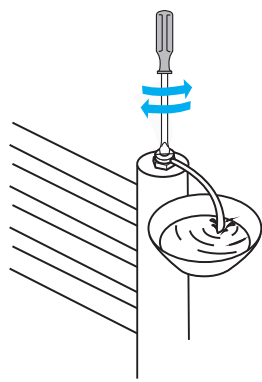
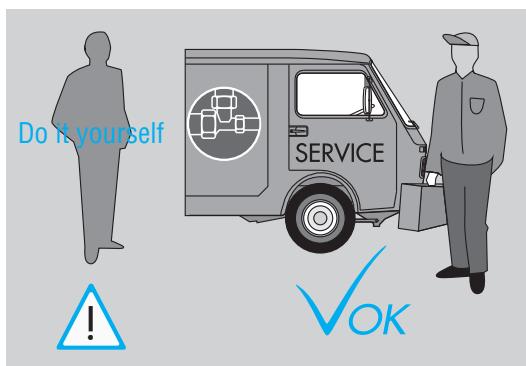

L	300	450	500	600	750
K	80	100	100	100	100

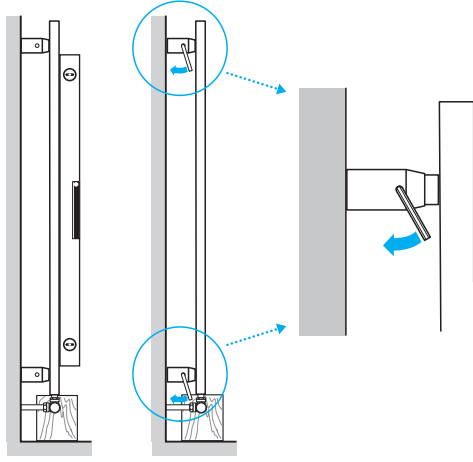
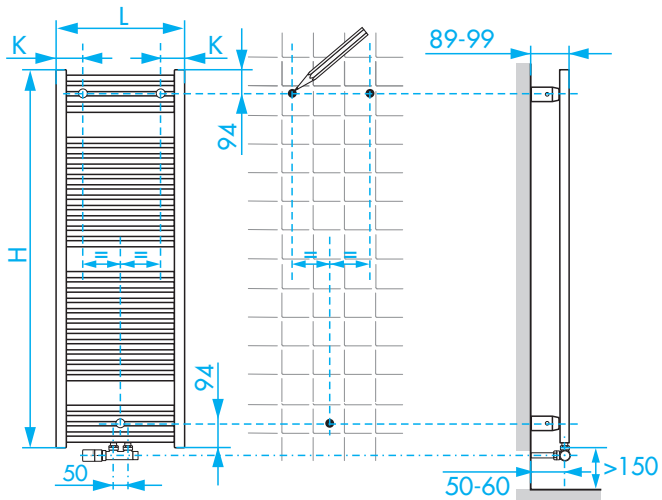
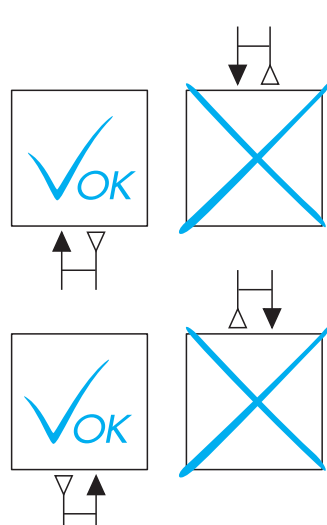
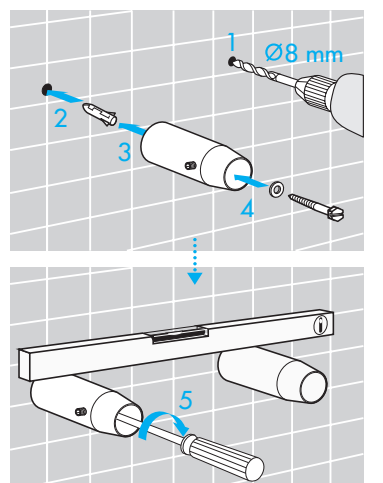
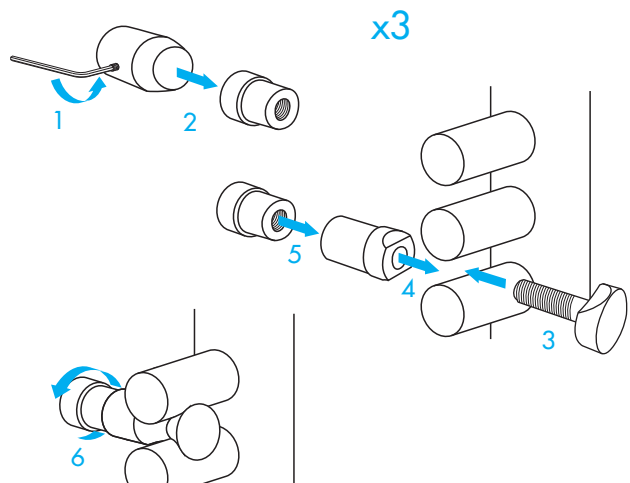
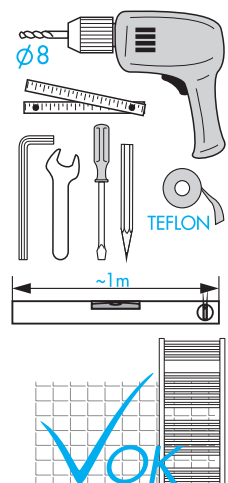
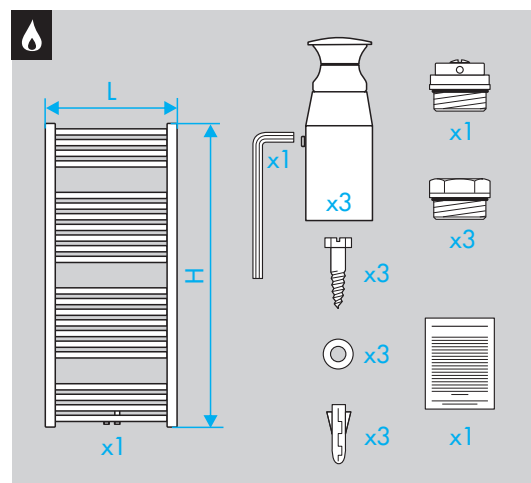
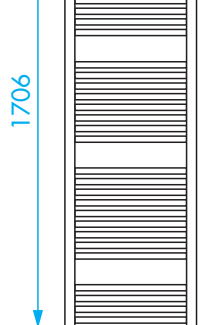
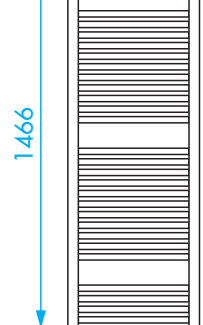
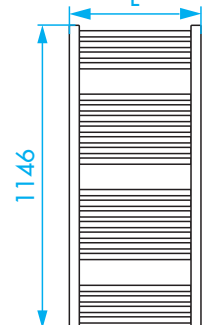
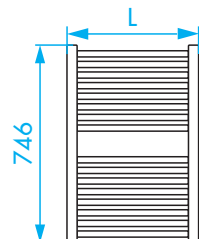

L	300	450	500	600	750
K	80	100	100	100	100

L	300	450	500	600	750
K	80	100	100	100	100

L	300	450	500	600	750
K	80	100	100	100	100

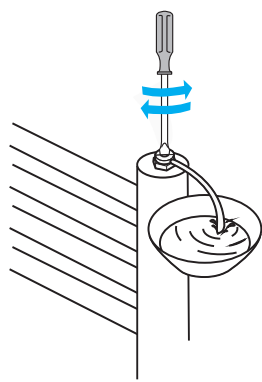
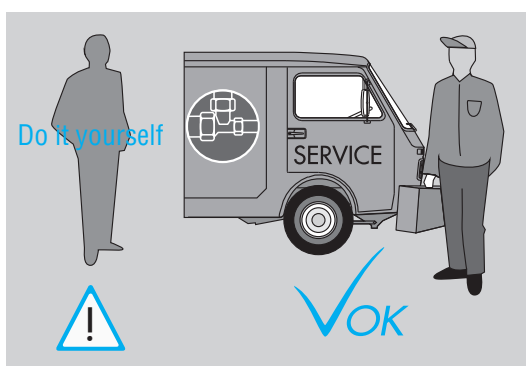

L	300	450	500	600	750
K	80	100	100	100	100

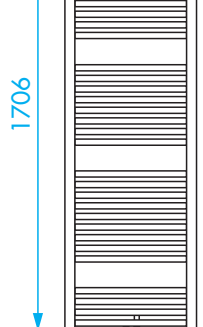
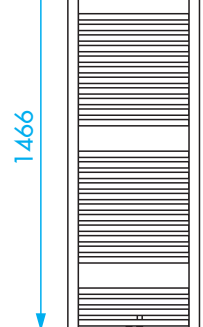
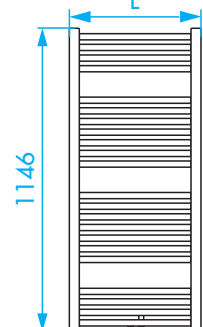
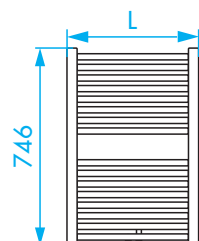

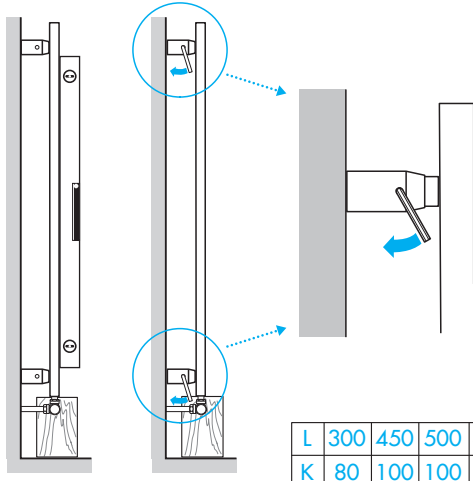
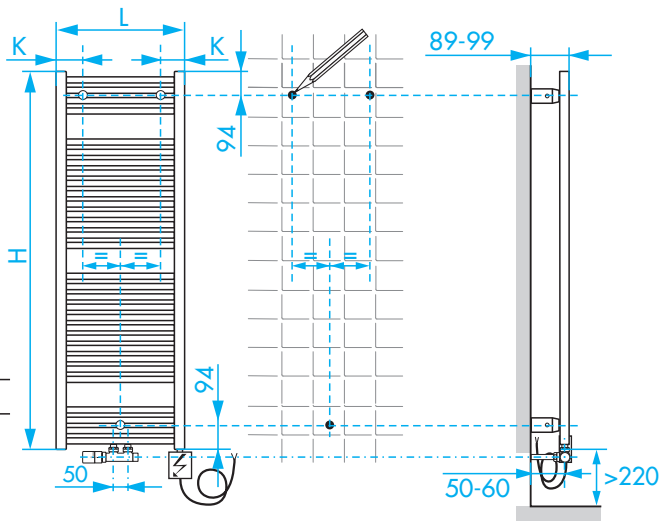
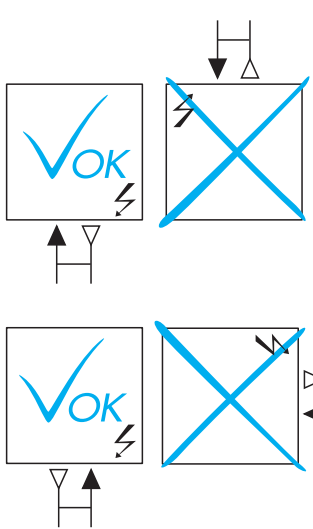
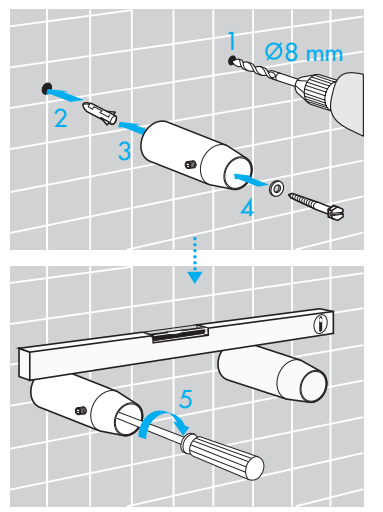
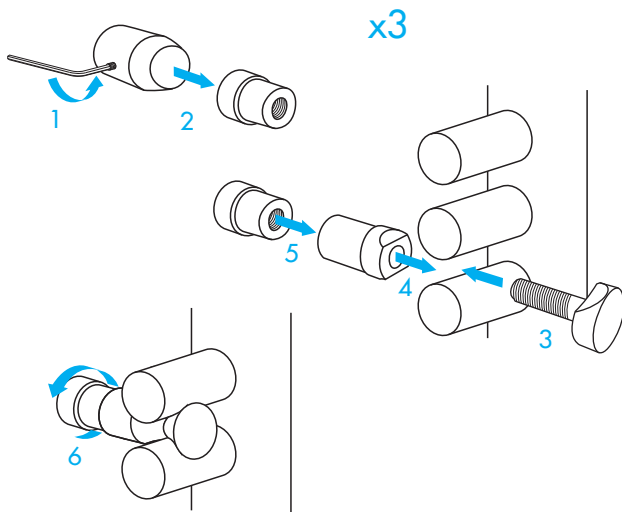
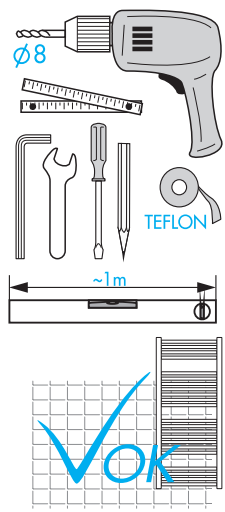
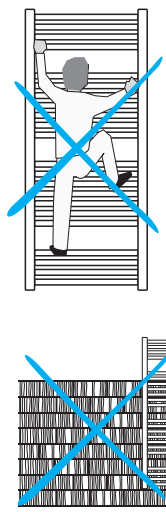
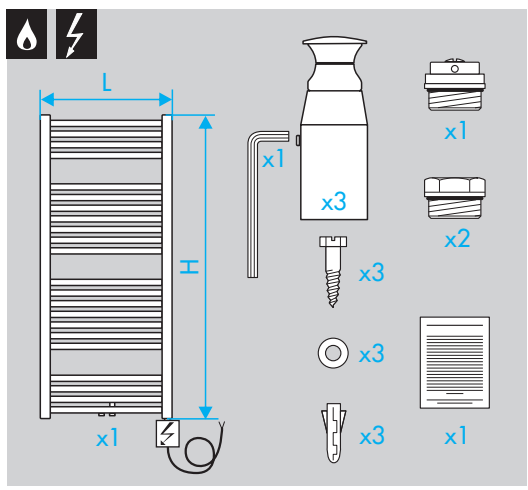

L	300	450	500	600	750
K	80	100	100	100	100

L	300	450	500	600	750
K	80	100	100	100	100

L	300	450	500	600	750
K	80	100	100	100	100

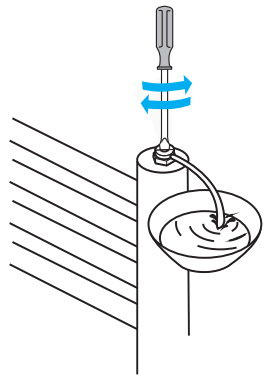
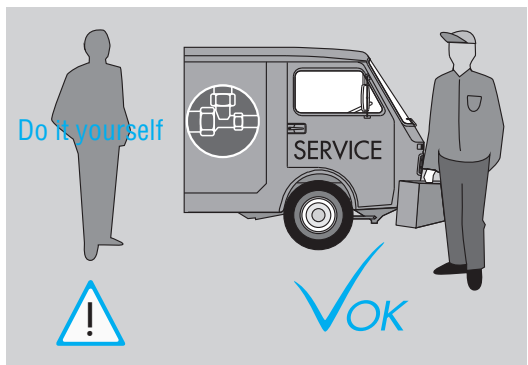

L	300	450	500	600	750
K	80	100	100	100	100

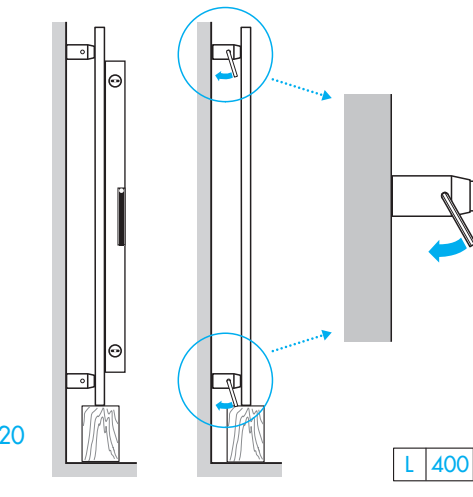
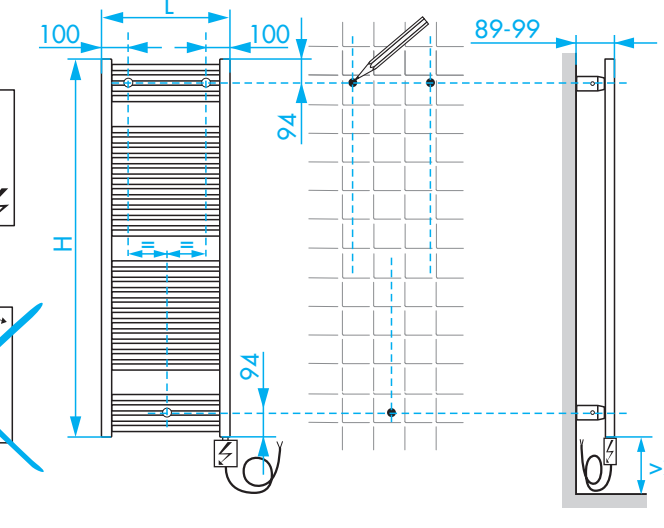
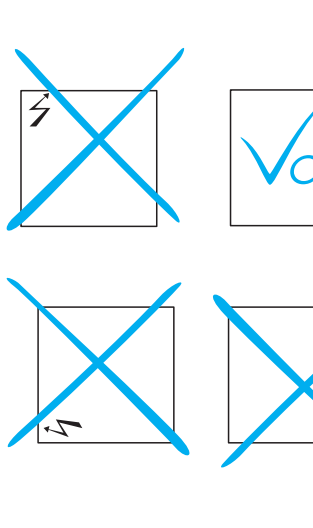
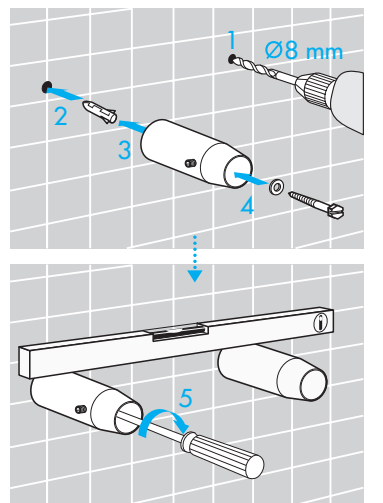
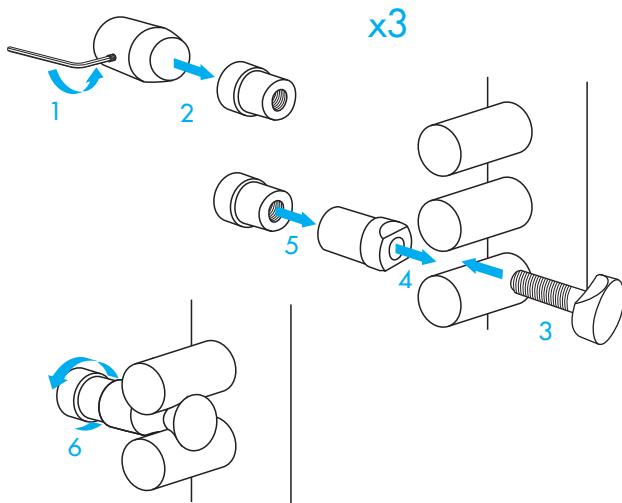
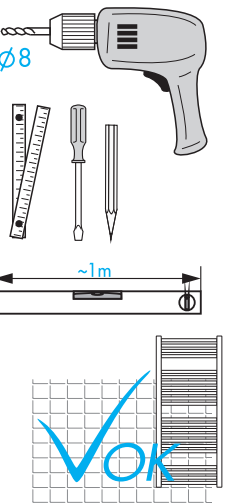
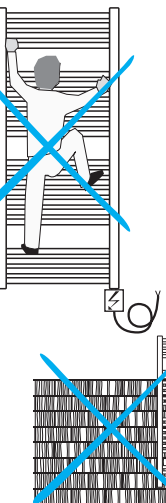
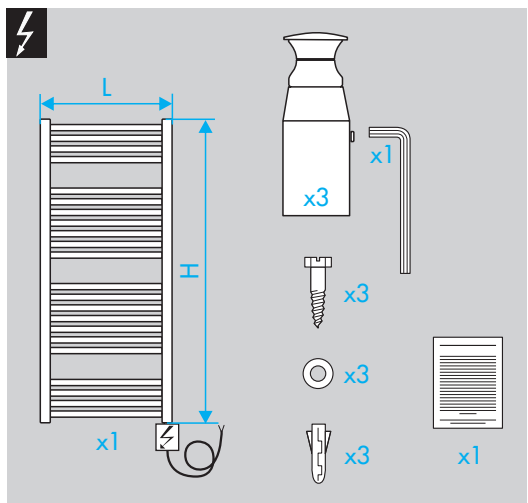
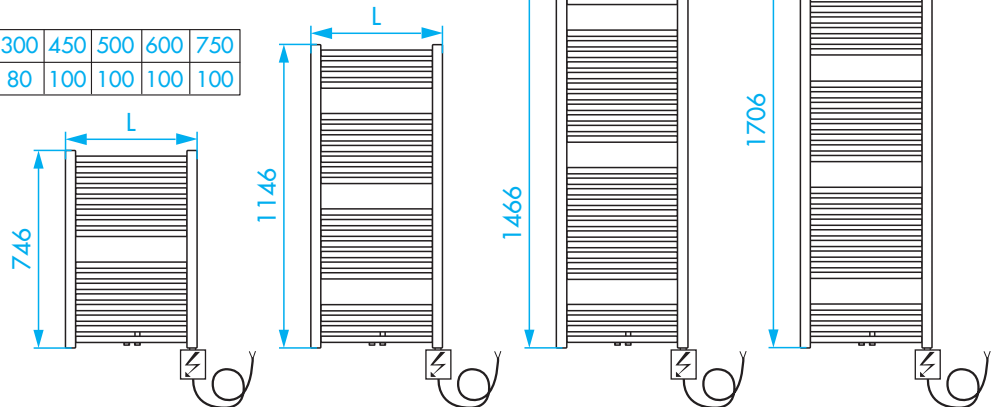

L	400	500
---	-----	-----

L	400	500
---	-----	-----

L	400	500
---	-----	-----

L	400	500
---	-----	-----

